



DESCRIPTION:

With high ability to withstand the shock loading of large current, JCT620EH SCR provides high dV/dt rate with strong resistance to electromagnetic interference. It is especially recommended for use on solid state relay, motorcycle, power charger, T-tools etc. Package TO-263 is RoHS compliant.

MAIN FEATURES

Symbol	Value	Unit
$I_{T(RMS)}$	20	A
V_{DRM}/V_{RRM}	600	V
I_{GT}	≤ 15	mA

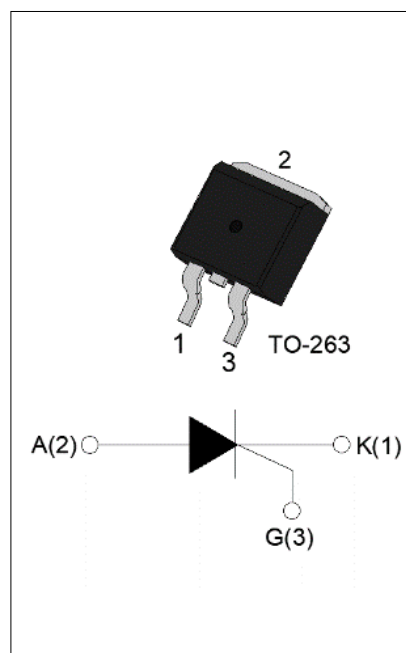

ABSOLUTE MAXIMUM RATINGS

Parameter	Symbol	Value	Unit
Storage junction temperature range	T_{stg}	-40-150	$^{\circ}C$
Operating junction temperature range	T_j	-40-150	$^{\circ}C$
Repetitive peak off-state voltage ($T_j=25^{\circ}C$)	V_{DRM}	600	V
Repetitive peak reverse voltage ($T_j=25^{\circ}C$)	V_{RRM}	600	V
Average on-state current ($T_c \leq 128^{\circ}C$)	$I_{T(AV)}$	13	A
RMS on-state current ($T_c \leq 128^{\circ}C$)	$I_{T(RMS)}$	20	A
Non repetitive surge peak on-state current ($t_p=10ms, T_j=25^{\circ}C$)	I_{TSM}	250	A
Non repetitive surge peak on-state current ($t_p=8.3ms, T_j=25^{\circ}C$)		275	
I^2t value for fusing ($t_p=10ms, T_j=25^{\circ}C$)	I^2t	312.5	A^2s
Critical rate of rise of on-state current ($I_G=2 \times I_{GT}, f=100Hz, T_j=150^{\circ}C$)	di/dt	150	$A/\mu s$
Peak gate current ($t_p=20\mu s, T_j=150^{\circ}C$)	I_{GM}	5	A
Average gate power dissipation ($T_j=150^{\circ}C$)	$P_{G(AV)}$	1	W

Peak gate power	P_{GM}	20	W
Peak pulse voltage ($T_j=25^{\circ}\text{C}$; non-repetitive, off-state; FIG.8)	V_{pp}	0.5	kV

ELECTRICAL CHARACTERISTICS ($T_j=25^{\circ}\text{C}$ unless otherwise specified)

Symbol	Test Condition	Value			Unit
		MIN.	TYP.	MAX.	
I_{GT}	$V_D=12\text{V } R_L=33\Omega$	-	-	15	mA
V_{GT}		-	-	1	V
V_{GD}	$V_D=V_{DRM} T_j=150^{\circ}\text{C } R_L=3.3\text{k}\Omega$	0.2	-	-	V
I_L	$I_G=1.2I_{GT}$	-	-	60	mA
I_H	$I_T=500\text{mA}$	-	-	50	mA
dV/dt	$V_D=400\text{V}$ Gate Open $T_j=125^{\circ}\text{C}$	500	-	-	V/ μs
	$V_D=400\text{V}$ Gate Open $T_j=150^{\circ}\text{C}$	300	-	-	
t_{on}	$I_G=40\text{mA } I_A=400\text{mA } I_R=40\text{mA}$ $T_j=25^{\circ}\text{C}$	-	5	-	μs
t_{off}		-	70	-	

STATIC CHARACTERISTICS

Symbol	Parameter		Value(MAX.)	Unit
V_{TM}	$I_{TM}=40\text{A } t_p=380\mu\text{s}$	$T_j=25^{\circ}\text{C}$	1.55	V
V_{TO}	Threshold voltage	$T_j=150^{\circ}\text{C}$	0.72	V
R_D	Dynamic resistance	$T_j=150^{\circ}\text{C}$	20	m Ω
I_{DRM}	$V_D=V_{DRM} V_R=V_{RRM}$	$T_j=25^{\circ}\text{C}$	5	μA
I_{RRM}		$T_j=150^{\circ}\text{C}$	3	mA

THERMAL RESISTANCES

Symbol	Parameter	Value	Unit
$R_{th(j-c)}$	junction to case(DC)	0.84	$^{\circ}\text{C/W}$
$R_{th(j-a)}$	junction to ambient (DC, in free air, $S=1\text{cm}^2$)	55	$^{\circ}\text{C/W}$

ORDERING INFORMATION

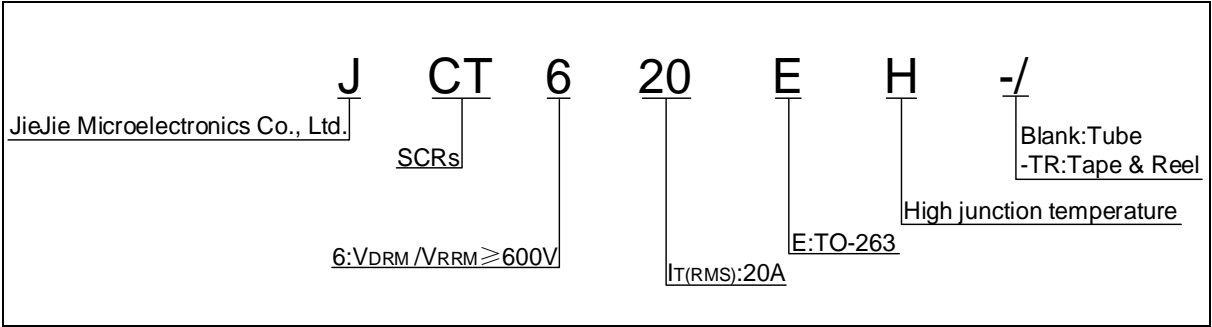

MARKING

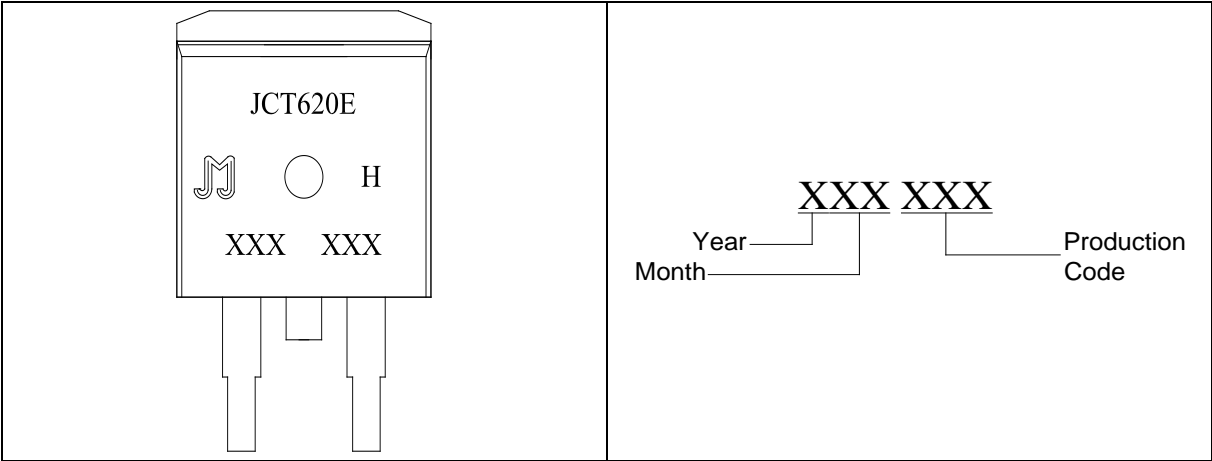

FIG.1: Maximum power dissipation versus RMS on-state current

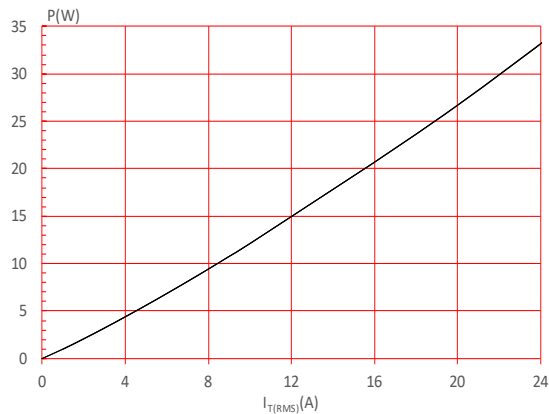

FIG.2: RMS on-state current versus case temperature

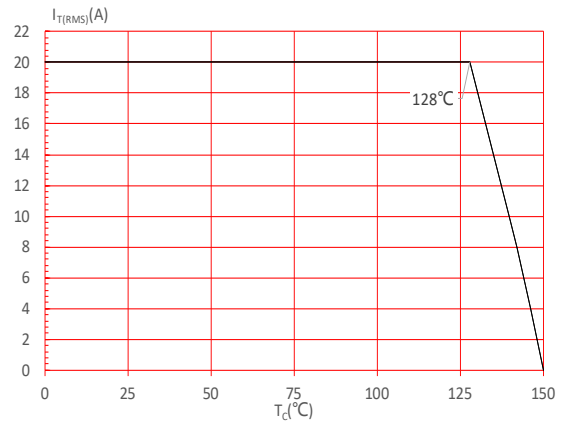

FIG.3: RMS on-state current versus ambient temperature (printed circuit board FR4,copper thickness:35μm)(full cycle)

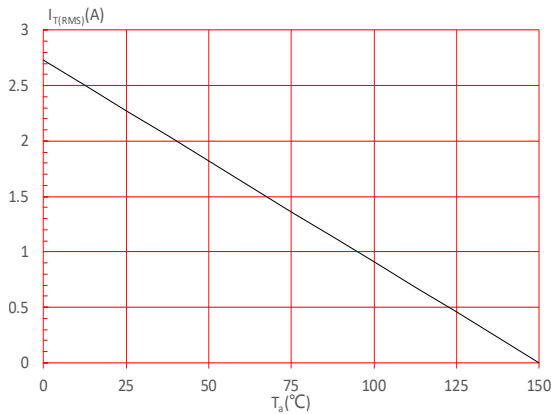

FIG.4: Surge peak on-state current versus number of cycles

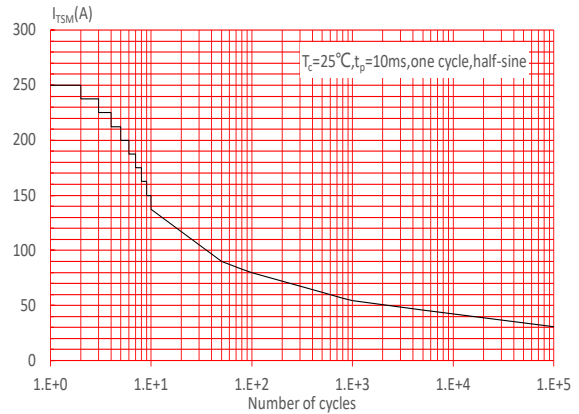

FIG.5: On-state characteristics

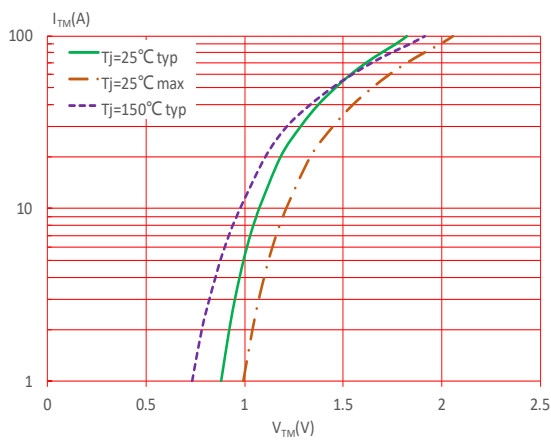

FIG.6: Non-repetitive surge peak on-state current for a sinusoidal pulse with width $t_p < 10\text{ms}$, and corresponding value of I^2t ($di/dt < 150\text{A}/\mu\text{s}$)

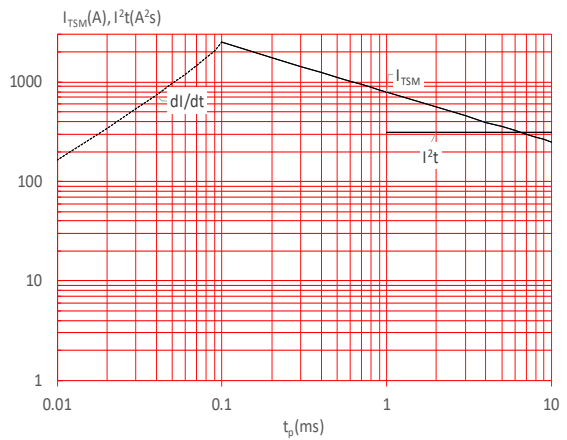

FIG.7: Relative variations of gate trigger current, holding current and latching current versus junction temperature

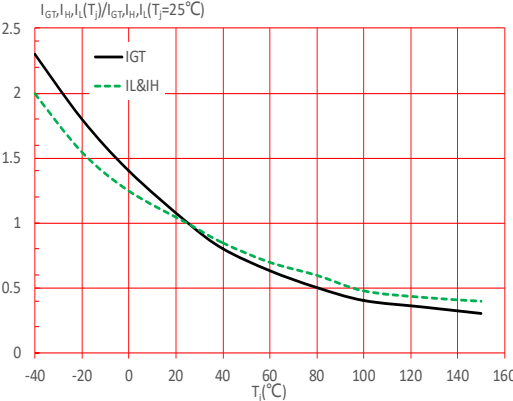
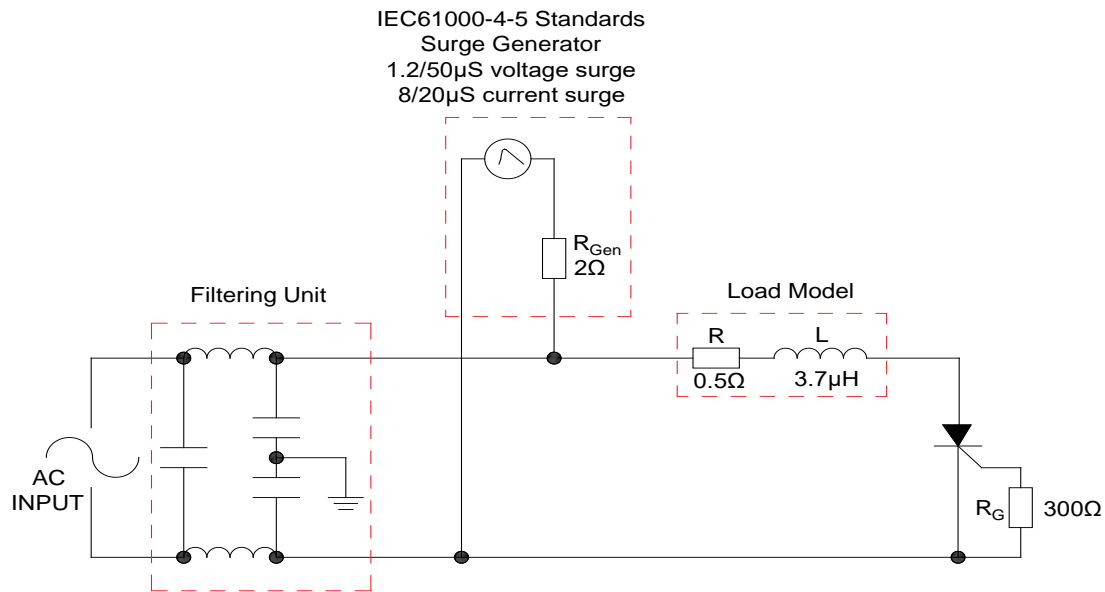
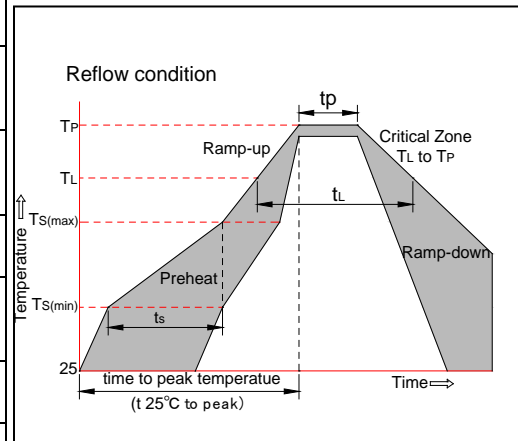

FIG.8: Test circuit for inductive and resistive loads to IEC-61000-4-5 standards.



SOLDERING PARAMETERS

Reflow Condition		Pb-Free assembly (see figure at right)
Pre Heat	-Temperature Min ($T_{s(min)}$)	+150°C
	-Temperature Max($T_{s(max)}$)	+200°C
	-Time (Min to Max) (t_s)	60-180 secs.
Average ramp up rate (Liquidus Temp (T_L) to peak)		3°C/sec. Max
$T_{s(max)}$ to T_L - Ramp-up Rate		3°C/sec. Max
Reflow	-Temperature(T_L) (Liquidus)	+217°C
	-Temperature(t_L)	60-150 secs.
Peak Temp (T_p)		+260(+0/-5)°C
Time within 5°C of actual Peak Temp (t_p)		20-40secs.
Ramp-down Rate		6°C/sec. Max
Time 25°C to Peak Temp (T_p)		8 min. Max
Do not exceed		+260°C



ORDERING INFORMATION

Order code	Voltage V_{DRM}/V_{RRM} (V)	IGT(mA)	Package	Base qty. (pcs)	Delivery mode
JCT620EH	600	15	TO-263	50	Tube
JCT620EH-TR				800	Tape & Reel

Document Revision History

Date	Revision	Changes
Jun.8, 2023	A.1.0	Last update
Oct.16, 2025	A.1.1	Revise PACKAGE MECHANICAL DATA

PACKAGE MECHANICAL DATA

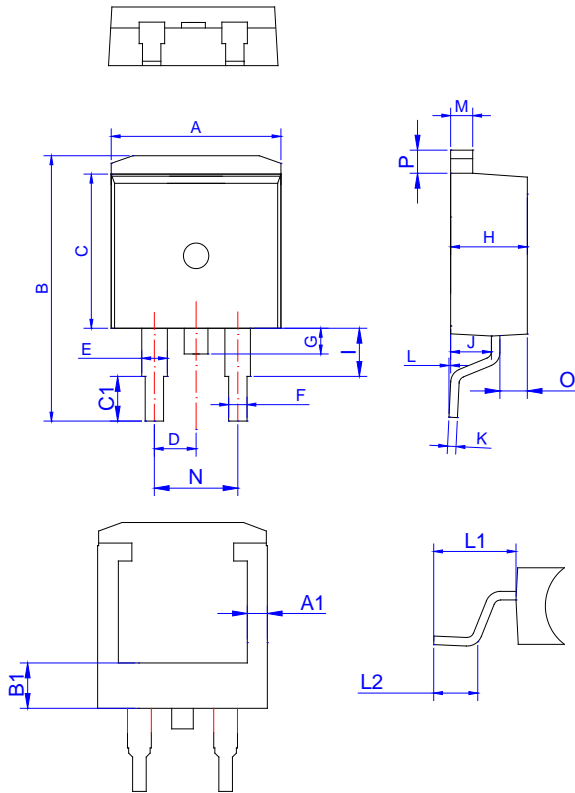

Ref.	Dimensions					
	Millimeters			Inches		
	Min.	Typ.	Max.	Min.	Typ.	Max.
A	9.90		10.20	0.390		0.402
A1	0.80		1.20	0.031		0.047
B	14.70		15.80	0.579		0.622
B1	2.15		2.55	0.085		0.100
C	9.40		9.60	0.370		0.378
C1	2.40		2.80	0.094		0.110
D	2.40		2.70	0.094		0.106
E	1.20		1.50	0.047		0.059
F	0.75		0.85	0.029		0.033
G	1.00		1.50	0.039		0.059
H	4.40		4.70	0.173		0.185
I	1.80		2.20			
J	2.30		2.70	0.091		0.106
K	0.38		0.55	0.015		0.022
L	0	0.10	0.25	0	0.004	0.010
L1	4.65		5.05	0.183		0.199
L2	1.90			0.075		
M	1.25		1.35	0.049		0.053
N	4.80		5.20			
O	1.30		1.50			
P	1.20		1.50	0.047		0.059

FOOTPRINT-TO-263 (dimensions in mm)

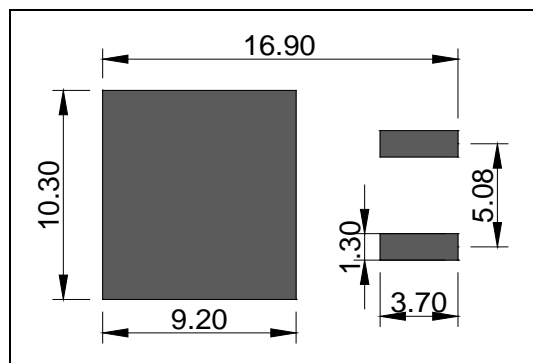

DELIVERY MODE

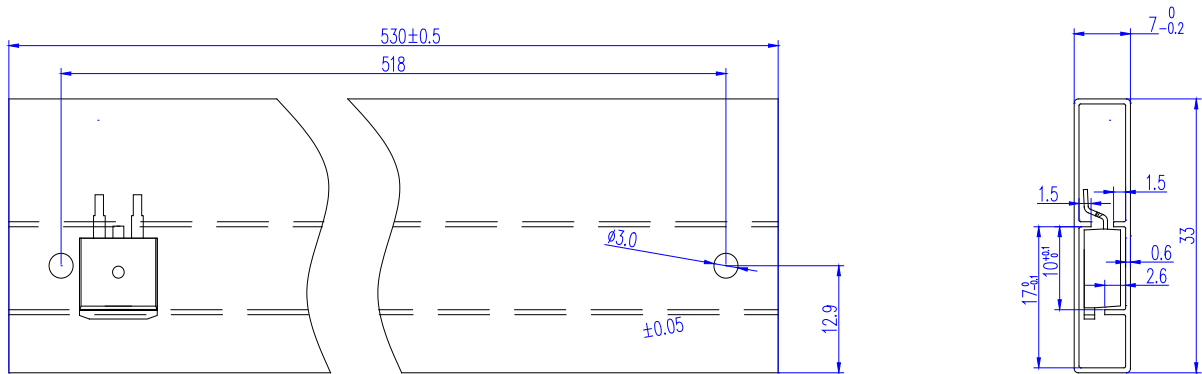

PACKAGE	OUTLINE	TUBE (PCS)	INNER BOX (PCS)	PER CARTON
TO-263	TUBE	50	1,000	5,000

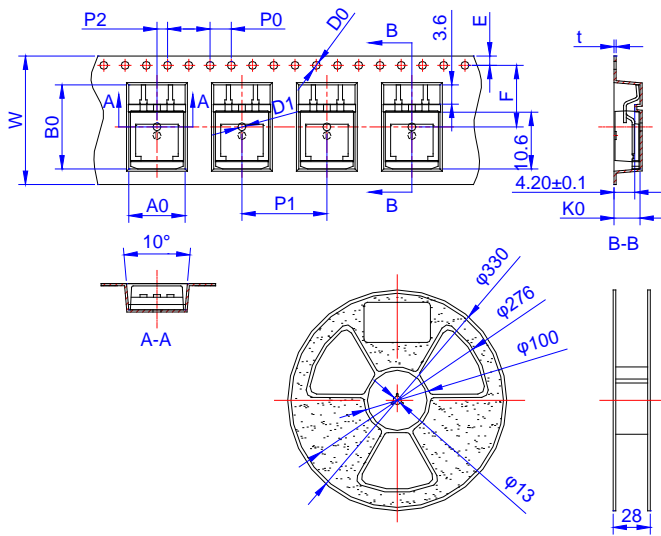

Ref.	Dimensions					
	Millimeters			Inches		
	Min.	Typ.	Max.	Min.	Typ.	Max.
W	23.70	24.00	24.30	0.933	0.945	0.957
E	1.65	1.75	1.85	0.065	0.069	0.073
F	11.40	11.50	11.60	0.449	0.453	0.457
D0	-	1.50	1.60	-	0.059	0.063
D1	-	1.50	1.60	-	0.059	0.063
P0	3.90	4.00	4.10	0.154	0.157	0.161
P1	15.90	16.00	16.10	0.626	0.630	0.634
P2	1.90	2.00	2.10	0.075	0.079	0.083
A0	10.80	10.90	11.00	0.425	0.429	0.433
B0	16.20	16.30	16.40	0.638	0.642	0.646
K0	4.80	4.90	5.00	0.189	0.193	0.197
t	0.35	0.40	0.45	0.014	0.016	0.018

PACKAGE	OUTLINE	REEL (PCS)	PER CARTON (PCS)	TAPE & REEL
TO-263	TAPING	800	4,000	13 inch

Information furnished in this document is believed to be accurate and reliable. However, Jiangsu JieJie Microelectronics Co., Ltd. assumes no responsibility for the consequences of use without consideration for such information nor use beyond it. Information mentioned in this document is subject to change without notice, apart from that when an agreement is signed, Jiangsu JieJie complies with the agreement. Products and information provided in this document have no infringement of patents. Jiangsu JieJie assumes no responsibility for any infringement of other rights of third parties which may result from the use of such products and information. This document supersedes and replaces all information previously supplied.

 is a registered trademark of Jiangsu JieJie Microelectronics Co., Ltd. Copyright © 2025 Jiangsu JieJie Microelectronics Co., Ltd. All rights reserved.